

UR 22C

USB AUDIO INTERFACE



Contents

Main Features	2
Panel Controls and Terminals	3
Front Panel	3
Rear Panel	5
Software	6
Yamaha Steinberg USB Driver	6
dspMixFx UR-C.....	8
Dedicated Windows for Cubase Series	13
Sweet Spot Morphing Channel Strip	16
REV-X	18
Guitar Amp Classics	20
Using with a Computer	23
Connection Example	23
Configuring Audio Driver Settings on the DAW Software	24
Recording/Playback	25
Using with an iOS Device	27
Connection Example	27
Recording/Playback	28
Troubleshooting.....	30
Appendix.....	33
Limitations on the use of effects	33
Computer connector types	33
Signal Flows.....	34
Block Diagrams.....	35
Technical Specifications	37
General Specifications	38
Uninstalling TOOLS for UR-C	39

Main Features

2 x 2 USB 3.0 Audio Interface with 2 x D-PRE and 32-bit/192 kHz support

The UR22C is a 2-in and 2-out USB 3.0 audio interface, featuring two world-renowned D-PRE microphone preamps and supporting 192 kHz and 32-bit audio quality to capture all the subtleties and expressiveness of any audio source.

True 32-bit resolution

The UR22C and the Yamaha Steinberg USB Driver support the 32-bit Integer format, which can represent audio data in higher resolution compared to Float format. Together with a DAW (such as Cubase) which can fully utilize the 32-bit Integer data, they enable unprecedented audio resolution in your music production.

USB 3.0 & USB Type-C

The UR22C is equipped with a USB Type-C port and features USB 3.0 (USB 3.1 Gen 1) SuperSpeed mode. It also provides full compatibility with the USB 2.0 High-Speed mode and includes a Type-C to Type-A cable.

dspMixFx

The dspMixFx technology is powered by the latest SSP3 DSP chip and offers latency-free monitoring with highly acclaimed DSP effects, including REV-X reverb, for users of any DAW software.

Panel Controls and Terminals

Front Panel

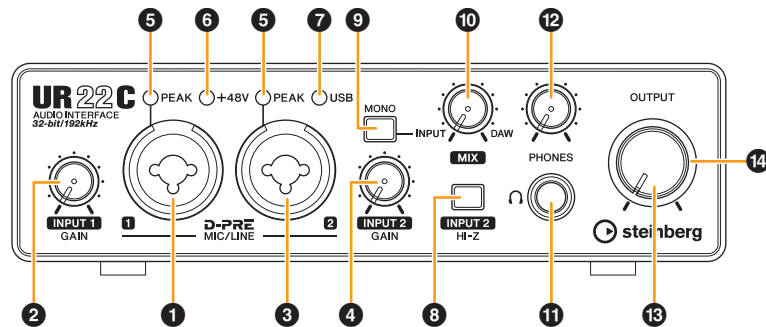

1 [MIC/LINE 1] jack

For connection to a microphone or digital instrument. This jack can be connected to both XLR-type and phone-type (balanced/unbalanced) plugs.

Plug types

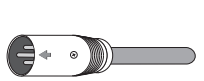

XLR-type (balanced)



Phone-type (balanced)



Phone-type (unbalanced)

NOTE

The phantom power will be supplied to the XLR jack connected to the [MIC/LINE 1] jack.

2 [INPUT 1 GAIN] knob

Adjusts the input signal level of the [MIC/LINE 1] jack.

3 [MIC/LINE 2] jack

For connection to a microphone, digital instrument, electric guitar, or electric bass. This jack can be connected to both XLR-type and phone-type (balanced/unbalanced) plugs.

NOTE

The phantom power will be supplied to the XLR jack connected to the [MIC/LINE 2] jack.

4 [INPUT 2 GAIN] knob

Adjusts the input signal level of the [MIC/LINE 2] jack.

5 [PEAK] indicator

Lights up according to the input signal. Lights up when the input signal is 3 dB below the clipping level.

Setting optimum recording levels

Adjust the [INPUT GAIN] knobs so that the [PEAK] indicator flashes briefly at the loudest input volume.

6 [+48V] indicator

Lights up when the [+48V] switch (phantom power) is turned on.

7 [USB] indicator

Lights up when the power is turned on and the unit is communicating with the computer or iOS device. The indicator flashes continuously when the computer or iOS device does not recognize the device.

8 [INPUT 2 HI-Z] switch

Switches the input impedance (on /off). Turn this switch on when connecting high impedance instruments, such as an electric guitar or electric bass, directly to the [MIC/LINE 2] jack. When you turn this switch on, use an unbalanced phone plug for connection between the instruments and the [MIC/LINE 2] jack.



CAUTION

To protect your speaker system, leave the monitor speakers turned off when turning the [INPUT 2 HI-Z] switch on/off. It's also a good idea to turn all output level controls down to their minimum. Neglect of these precautions may result in loud noise bursts that may damage your equipment, your ears, or both.

NOTICE

Do not connect or disconnect any cables while turning on the [INPUT 2 HI-Z] switch. Doing so can damage the connected device and/or the unit itself.

NOTE

- If you use a balanced phone plug, the device will not work correctly.
- When the HI-Z switch is turned on, the signal from the XLR-type is cut off.

9 [MONO] switch

When this switch is on, the input to the [MIC/LINE 1/2] jacks is output to both the [MAIN OUT L/R] jacks and the L/R channel of the [PHONES] jack. When the switch is off, the input to the [MIC/LINE 1] jacks is output to the [MAIN OUT L] jack and the input to the [MIC/LINE 2] jacks is output to the [MAIN OUT R] jack.

For the [PHONES] jack, the input to the [MIC/LINE 1] jacks is output to the L channel and the input to the [MIC/LINE 2] jacks is output to the R channel.

10 [MIX] knob

Adjusts the signal level balance between the input signal to the [MIC/LINE 1/2] jacks and the signal from an application, such as DAW software. Both of the signals to the [MIC/LINE 1/2] jacks are mixed as a mono signal. Operation of this control knob does not affect the signal sent to a computer.

Using the Mix knob

Turn the [MIX] knob to the [DAW] side if the input volume is high and to the [INPUT] side if the input volume is low. When the knob is turned fully to the [DAW] side, only the input sound from DAW can be heard.

11 [PHONES ] jack

For connection to a set of stereo headphones.

12 [PHONES] knob

Adjusts the output signal level of the [PHONES] jack.

13 [OUTPUT] knob

Adjusts the output signal level of the [MAIN OUTPUT] jacks.

14 POWER indicator

Lights up when the power is turned on. The indicator flashes continuously if the power supply is insufficient. In this case, use the USB power adapter or USB mobile battery.

Rear Panel

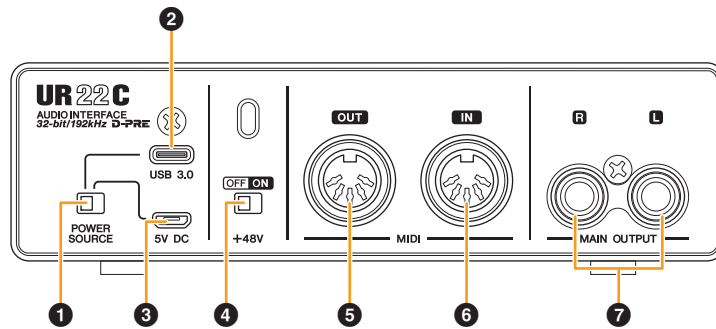

1 [POWER SOURCE] switch

For selecting the port for supplying power to the UR22C. To supply bus power via the [USB 3.0] port, set this switch to the [USB 3.0] side. To supply power via the [5V DC] port, set this switch to the [5V DC] side.

2 [USB 3.0] port

For connection to a computer or iOS device.

NOTICE

When connecting to a computer with a [USB 3.0] port, observe the following to prevent the computer from freezing or shutting down, as well as corruption or even loss of data.

- Before connecting/disconnecting the USB cable, be sure to observe the following points.
 - Quit all open software applications on the computer.
 - Set all output level controls to the minimum.
- Wait at least six seconds between connecting/disconnecting the USB cable.

NOTE

Apple accessories may be required when connecting the UR22C with iOS devices. For details, refer to the UR22C Startup Guide.

3 [5V DC] port

For connecting a USB power adapter or USB mobile battery. Use a power supply when connecting the UR22C to a device that does not supply sufficient bus power, such as an iPad. (The UR22C does not include a USB power adapter or USB mobile battery.)

NOTICE

- Read the safety precautions for the USB power adapter or USB mobile battery that you use.
- Use a USB power adapter or USB mobile battery that can supply power in compliance with USB standards with a 5-pin micro USB plug.
 - Output voltage 4.8 V to 5.2 V
 - Output current 0.9 A or greater

Using the [5V DC] port

Even when the UR22C is connected to a computer, you can supply power via the [5V DC] port by external power supply if the [POWER SOURCE] switch is set to the [5V DC] side. This can be used to avoid power supply problems. For example, ground loops due to differences in voltage potential can occur if the device connected to the UR22C is using the same power outlet as the computer, and audio quality degradation can occur if the power supply from the computer's USB port is not stable.

4 [+48V] switch

Turns the phantom power on/off. When you turn this switch on, phantom power will be supplied to the XLR jack connected to the [MIC/LINE 1/2] jacks. Turn this switch on when using a phantom powered condenser microphone.

NOTICE

When using phantom power, observe the following to prevent noise and possible damage to UR22C or connected equipment.

- Do not connect or disconnect any devices while the phantom power switch is turned to ON.
- Set all output level controls to the minimum before turning the phantom power switch to ON or OFF.
- When connecting devices not requiring phantom power to the [MIC/LINE 1/2] jack, make sure to turn the phantom power switch to OFF.

NOTE

When the phantom power switch is turned on and off, all inputs/outputs will be muted for a few seconds.

5 [MIDI OUT] jack

For connection to the MIDI IN jack of the MIDI device. Transmits MIDI signals from the computer.

6 [MIDI IN] jack

For connection to the MIDI OUT jack of the MIDI device. Receives and inputs MIDI signals to the computer.

NOTE

- Select [Steinberg UR22C-port1] for the MIDI port when using a MIDI jack with an iOS app. Please note that [Steinberg UR22C-port2] is not available.
- Do not activate dspMixFx when using a MIDI device. This may interfere with stable data transmission/reception.

7 [MAIN OUTPUT L/R] jacks

For connection to monitor speakers. These jacks can be connected to phone-type (balanced/unbalanced) plugs. This outputs the MIX 1 signals. To adjust the output signal level, use the [OUTPUT] knob on the front panel.

Software

The section explains software operations for using the UR22C with a computer.

Yamaha Steinberg USB Driver

Yamaha Steinberg USB Driver is a software program that allows communication between the UR22C and a computer. In Control Panel, you can configure the basic settings for the audio driver (Windows) or confirm the audio driver information (Mac).

How to Open the Window

Windows

- From the start menu, select [Yamaha Steinberg USB Driver] → [Control Panel].
- From the Cubase series menu, select [Studio] → [Studio Setup] → [Yamaha Steinberg USB ASIO] → [Control Panel].

Click the upper tabs to select the desired window.

Mac

- Select [Application] → [Yamaha Steinberg USB Control Panel]
- From the Cubase series menu, select [Studio] → [Studio Setup] → [Steinberg UR22C (High Precision)] → [Control Panel] → [Open Config App]

Steinberg UR22C Window

These windows are for selecting the sample rate and the USB mode.

Windows

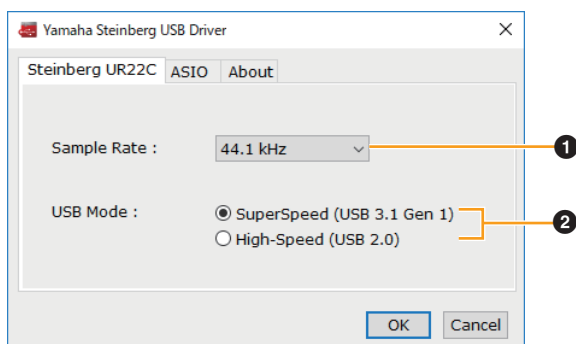

Mac

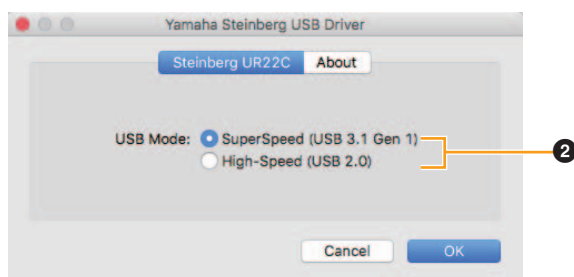

1 Sample Rate

Lets you select the sample rate of the device.

Settings: 44.1 kHz, 48 kHz, 88.2 kHz, 96 kHz, 176.4 kHz, 192 kHz

NOTE

The available sample rates may differ depending on the particular DAW you're using.

2 USB Mode

Lets you select the USB mode. The default setting is SuperSpeed (USB 3.1 Gen 1) mode.

Settings: SuperSpeed (USB 3.1 Gen 1), High-Speed (USB 2.0)

NOTE

If High-Speed (USB 2.0) mode is used, the data bandwidth will become narrower, but this will not affect the functionality of the UR22C. Other performance values such as latency will not change.

ASIO Window (Windows only)

For selecting the ASIO driver settings.

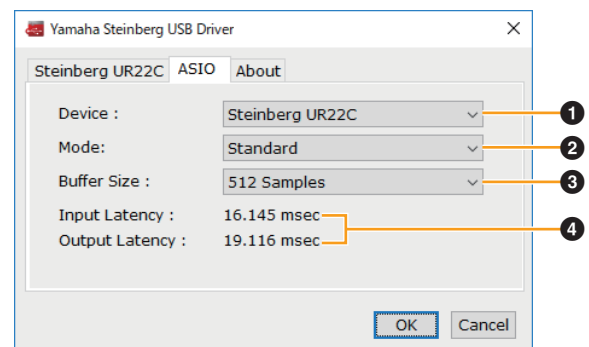

1 Device

Lets you select the device for use with the ASIO driver. This function is available when connecting two or more devices that are compatible with the Yamaha Steinberg USB Driver to the computer.

2 Mode

Lets you select the latency mode.

Settings: Low Latency, Standard, Stable

Sample Rate	Descriptions
Low Latency	Low latency mode. High-performance computer is required.
Standard	Standard latency mode.
Stable	High latency mode. This prioritizes stability for low-performance computer and high-load projects.

3 Buffer Size

Lets you select the buffer size for the ASIO driver. The range varies depending on the specified sample rate. The lower the value of the ASIO buffer size, the lower the value of audio latency.

Sample Rate	Range
44.1 kHz / 48 kHz	32 Samples – 2048 Samples
88.2 kHz / 96 kHz	64 Samples – 4096 Samples
176.4 kHz / 192 kHz	128 Samples – 8192 Samples

4 Input Latency/Output Latency

Indicates the latency (delay time) for the audio input and output in millisecond units.

About Window

Indicates the version and copyright information of the audio driver.

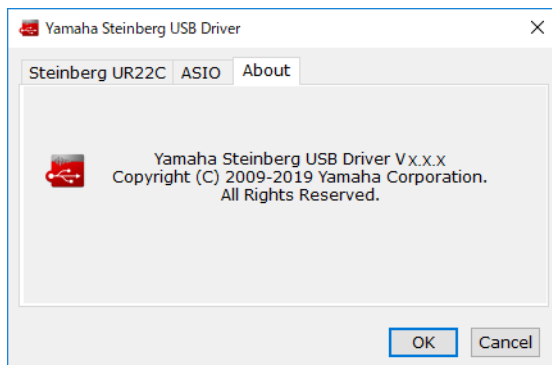

How to Select the Buffer Size (Mac)

You can select the buffer size in the settings window for each application (DAW software, etc.).

From the Cubase series menu, select [Studio] → [Studio Setup], then click [Control Panel] in [Steinberg UR22C] or [Steinberg UR22C (High Precision)] in the menu on the left side of the window.

The method for opening the settings window is different for each application.

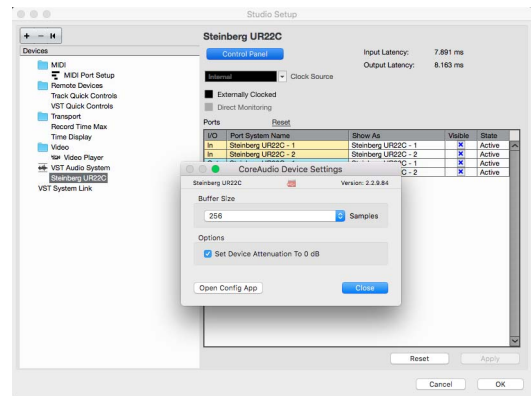

Using with 32-bit Integer processing (Mac)

[Steinberg UR22C] or [Steinberg UR22C (High Precision)] is shown in the [ASIO Driver] setting on the Cubase series program. Select [Steinberg UR22C (High Precision)] when processing at 32-bit integer resolutions between Cubase and the driver.

How to Select the Sample Rate (Mac)

You can select the sample rate in the [Audio MIDI Setup] window. Select the sample rate from the [Applications] → [Utilities] → [Audio MIDI Setup] → [Format] menu.

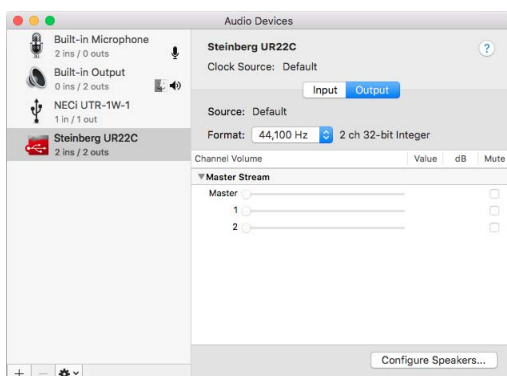

dspMixFx UR-C

This software is for operating the convenient built-in DSP mixer and DSP effects. The DSP mixer allows you to mix up to two input channels down to one stereo output. A number of DSP effects for processing the input signals are also provided, and since the processing/mixing is hardware-based, there is no monitoring latency.

Screenshot



How to Open the Window

Windows

[All Programs] or [All apps] → [Steinberg UR22C] → [dspMixFx UR-C]

Mac

[Application] → [dspMixFx UR-C]

Tool Area

This is the area for configuring the overall common settings of dspMixFx UR-C.

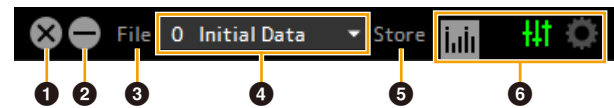

1 Quit

Quits dspMixFx UR-C.

2 Minimize

Minimizes the dspMixFx UR-C window.

3 File

Provides four different menus for various settings.

Menu	Descriptions
Open	Opens the settings file of dspMixFx UR-C.
Save	Saves the settings file of dspMixFx UR-C to a computer.
Import Scene	Imports a scene from the settings file of dspMixFx UR-C. Select the desired settings file of dspMixFx UR-C and import the desired scene on the left side of the [IMPORT SCENE] window. The window appears after the file is selected in the file selection dialog. Select the destination for importing on the right side of the window. Click [OK] to import it.
Initialize All Scenes	Initialize all the saved scenes.

4 Scene



Indicates the scene name. You can change the scene name by clicking on it. Clicking the button on the right opens the window for calling up other scenes. Call up the desired scene by clicking it. To cancel calling up the scene, click outside of the window.

5 Store

Opens the Scene Store window. Enter the desired scene name into the STORE NAME field. Select the destination for storing the scene in the No. NAME field. Click [OK] to store the scene.

6 Selecting windows

Selects the desired dspMixFx UR-C window. The selected window icon lights in red.

Menu	Description
	Main window
	Setup window
	Information window

Main Window

This window is for configuring the entire signal flow.

Channel Area ([page 9](#))

MIX Area ([page 11](#))



DAW Area ([page 10](#))

REV-X Area ([page 10](#))

Master Area ([page 11](#))

Channel Area

This is the area for configuring the input channel settings.

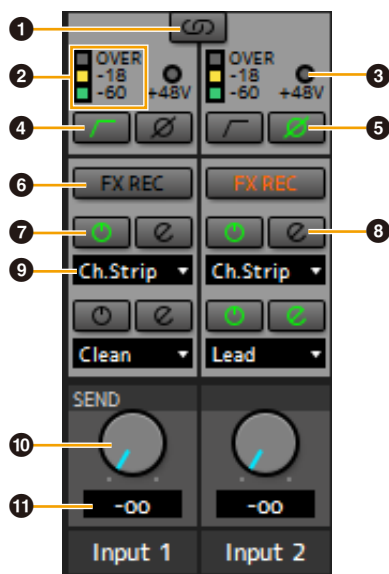

1 Channel Link

Turns on (lit) and off (unlit) the channel link function of two adjacent channels. When this is on, two mono channels will become one stereo channel.

2 Level Meter

Indicates the signal level.

3 +48V

Indicates the on/off status of the phantom power function of the device.

4 High Pass Filter

Turns on (lit) and off (unlit) the high pass filter. To select the cutoff frequency of the high pass filter, use the "Setup Window" ([page 12](#)) in the section "dspMixFx UR-C."

5 Phase

Turns on (lit) and off (unlit) the phase inversion of the signal.

6 FX REC

Turn the FX REC (effect recording) on and off.

Settings	Description
On (lit)	Applies an effect to both the monitor signal (sent to the device) and the recording signal (sent to the DAW software).
Off (unlit)	Applies an effect to only the monitor signal (sent to the device).

7 Effect On/Off

Turns the Effect on (lit) and off (unlit).

8 Effect Edit

Opens (lit) and closes (unlit) the selected effect setup window.

9 Effect Type

Selects the effect type.

Settings: NoEffect, Ch.Strip, Clean, Crunch, Lead, Drive

NOTE

The maximum number of Channel Strip and Guitar Amp Classics iterations which can be used simultaneously is limited. Refer to the "Limitations on the use of effects" ([page 33](#)).

10 REV-X Send

Adjusts the signal level which is sent to REV-X.

Range: -∞ dB – +6.00 dB

11 REV-X Send Value

Displays and adjusts the REV-X send value. Enable editing of the value by double clicking the number.

DAW Area

This is the area for configuring the DAW channel settings.



1 Level Meter

Indicates the signal level.

REV-X Area

This is the area for configuring the REV-X channel settings.

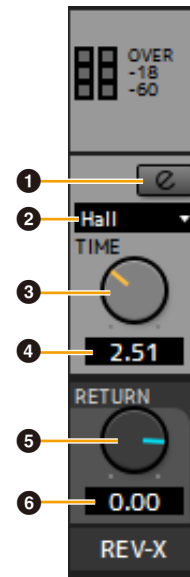

1 REV-X Edit

Opens (lit) and closes (unlit) the “REV-X” (page 18) setup window.

2 REV-X Type

Selects the REV-X type.

Settings: Hall, Room, Plate

3 REV-X Time

Adjusts the reverb time of REV-X. This parameter links to Room Size. The adjustable range varies depending on REV-X type.

REV-X Type	Range
Hall	0.103 sec – 31.0 sec
Room	0.152 sec – 45.3 sec
Plate	0.176 sec – 52.0 sec

4 REV-X Time Value

Displays and adjusts the REV-X Time value. Enable editing of the value by double clicking the number.

5 REV-X Return

Adjusts the return level of REV-X.

6 REV-X Return Value

Displays and adjusts the REV-X Return value. Enable editing of the value by double clicking the number.

MASTER Area

This is the area for configuring the master channel settings.

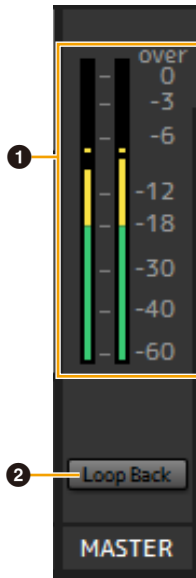

1 Level Meter

Indicates the signal level.

2 Loop Back

Turns the Loopback function on (lit) and off (unlit).

What is Loopback?

Loopback is a convenient function for broadcasting over the Internet. It mixes the input audio signals (such as microphone and guitar) with the audio signals playing back in the software in the computer into two channels in the UR22C, and sends them back to the computer. Refer to the section "Signal Flow" (page 34).

If the Loopback function is on while you are monitoring input signals from the UR22C via DAW software, it will cause loud noise. This is because an infinite loop of the audio signal is generated between the UR22C and the DAW software. When using the loopback function, turn off the monitor functions on your DAW software.

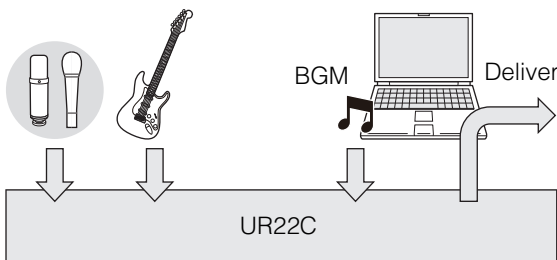

MIX Area

This is the area for selecting the MIX you want to configure. The UR22C can be set only to MIX1.



Meter Window

This window is for showing the meter at the top of the Main window.

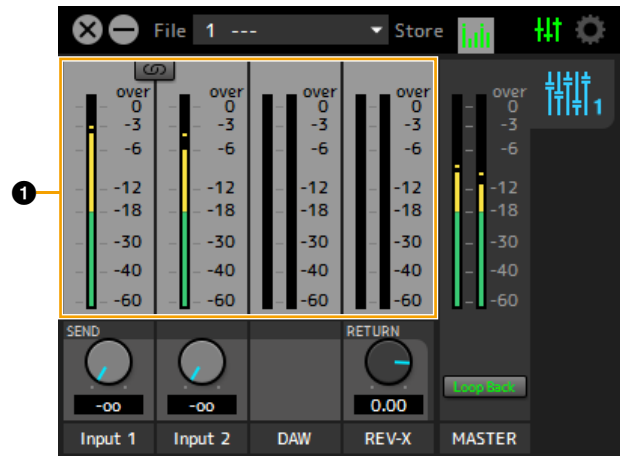

1 Level Meter

Indicates the signal level. Peak hold is normally set to on.

Display color	Description
Green	Up to -18dB
Yellow	Up to 0dB
Red	CLIP

Setup Window

This window is for configuring the common settings of the device.

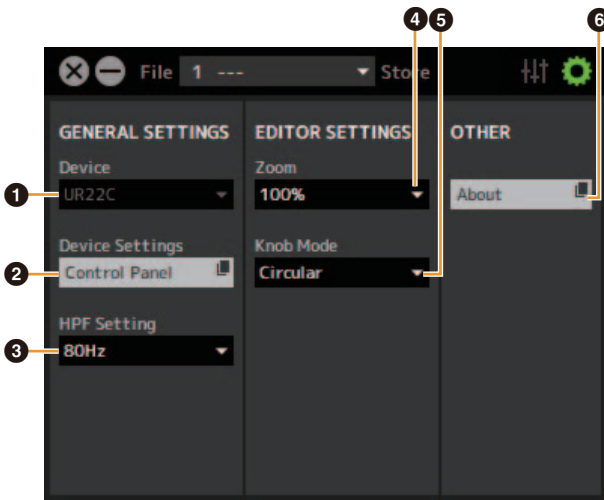

1 Device

Selects the device when simultaneously connecting one or more devices that are capable with dspMixFx.

2 Device Settings

Opens the Control Panel.

3 HPF Setting

Selects the cutoff frequency of the high pass filter.

Settings: 120 Hz, 100 Hz, 80 Hz, 60 Hz, 40 Hz

4 Zoom

Changes the window size.

Settings: 100%, 150%, 200%, 250%, 300%

5 Knob Mode

Selects the method of operating the knobs on dspMixFx UR-C.

Settings	Description
Circular	Drag in a circular motion to increase and decrease the parameter. Drag on a dial clockwise to increase, and counterclockwise to decrease. If you click any point on the knob, the parameter will jump there instantly.
Linear	Drag in a linear motion to increase and decrease the parameter. Drag upward or rightward to increase, and downward or leftward to decrease. Even if you click any point on the knob, the parameter will not jump there.

6 About

Indicates the version of the firmware and software.

Dedicated Windows for Cubase Series

These are the windows for configuring the device settings from Cubase series software. The dedicated windows for Cubase series allow you to configure the parameters which are configured by dspMixFx UR-C. Two types of windows are available: Input Settings and Hardware Setup.

Screenshot

Input Settings Window



Hardware Setup Window

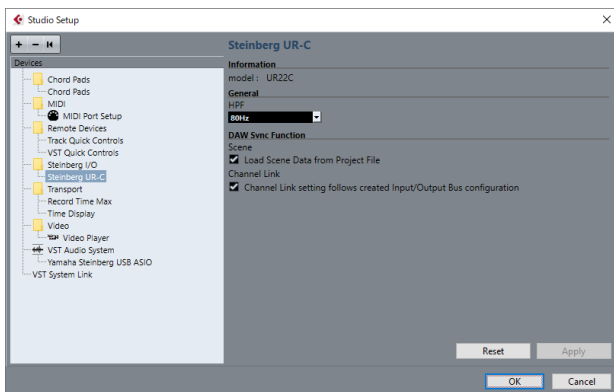

How to Open the Window

Input Settings Window

From the Cubase series menu, select [Project] → [Add track] → [Audio] to create an audio track and then click the [UR22C] tab on the inspector on the left side.

Hardware Setup Window

From the Cubase series menu,

- Select [Studio] → [Studio Setup], then select the [Steinberg UR-C] on the [Steinberg I/O] on the left side.
- From Input Settings Window, click [Hardware Setup]

Input Settings Window

This window is for configuring the input settings of the device. The signal flow is from top to bottom. The settings on this window (except for the +48V indicator) are saved to the Cubase project file.

The Input Settings Window is displayed on the audio track routing as UR22C.

Header Area

Display the name of the connected device and open the Editor.



1 model

Displays the model name (UR22C) in use. Switch between displayed or not displayed for the Input Settings Window by clicking it.

2 Hardware setup

Opens the Hardware Setup Window.

3 Editor Active

Opens dspMixFx UR-C.

Hardware Inputs Settings area.

This area is used to set parameters related to the UR22C inputs.

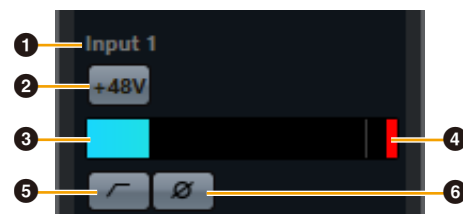

1 Port name

Displays the name of the port which is being used for input to the track of the device.

2 +48V

Indicates the on (lit) and off (unlit) status of the phantom power function of the device.

3 Input meter

Displays input levels.

4 Meter Clip

Displays the input meter clip when clipping occurs. Click this to stop this display.

5 High Pass Filter

Turns on (lit) and off (unlit) the high pass filter. To select the cutoff frequency of the high pass filter, use the "Hardware Setup Window" (page 15) in the section "dspMixFx UR-C."

⑥ Phase

Switches phase inversion on (lit) and off (unlit). Shows L, R when stereo is selected.

Effect Settings area

This area is used to set parameters related to the UR22C input/output port effects.

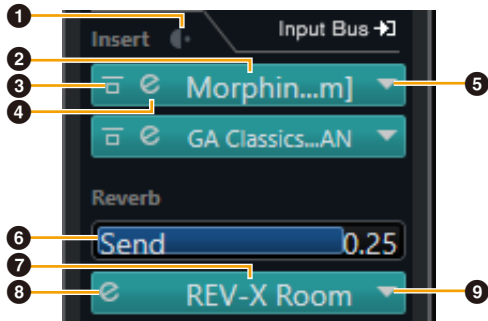

① Pre/Post

Used to select the insertion point for the effect.

② Effect Name

Displays the names of the applied effects.

③ Effect Bypass

Enables/bypasses the effect.

④ Effect Edit

Displays the Effect Edit window.

⑤ Effect Type

Selects the effect type.

Settings: No Effect, Morphing Ch Strip ([m] or [s]), GA Classics - CLEAN, GA Classics - CRUNCH, GA Classics - LEAD, GA Classics - DRIVE

NOTE

The maximum number of Channel Strip and Guitar Amp Classics iterations which can be used simultaneously is limited. Refer to the "Limitations on the use of effects" ([page 33](#)).

⑥ REV-X Send

Adjusts the signal level which is sent to REV-X.

Range: -∞ dB – +6.00 dB

⑦ REV-X Name

Displays the selected REV-X type.

⑧ REV-X Edit

Opens the "REV-X" ([page 18](#)) setup window.

⑨ REV-X Type

Selects the REV-X type.

Settings: Hall, Room, Plate

Outputs area

This area is used to set parameters related to hardware outputs.

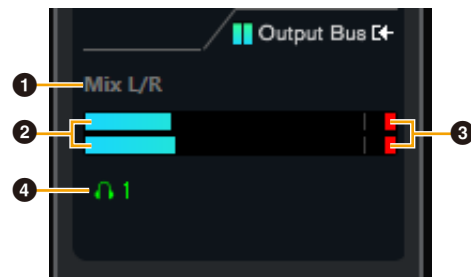

① Mix Bus name

Displays the Mix Bus name of the hardware output. The output bus of the track must be connected to this Mix bus.

② Output meter

Displays meters for the hardware Mix Bus connected to hardware outputs.

③ Meter Clip

Displays the input meter clip when clipping occurs. Click this to stop this display.

④ Headphones

The UR22C can be set only to phones1.

Hardware Setup Window

This window allows you to configure general hardware settings and Cubase-linked function settings.

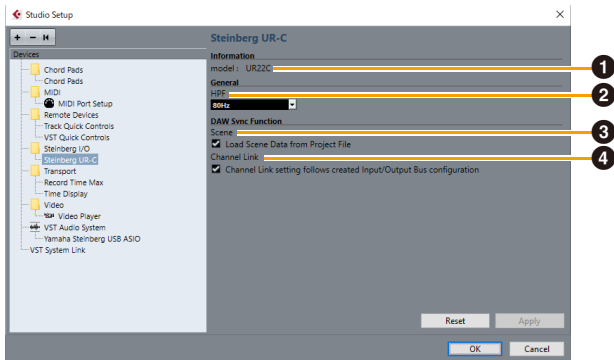

1 model

Displays the name of the device.

2 HPF

Selects the cutoff frequency of the high pass filter.

Settings: 120Hz, 100Hz, 80Hz, 60Hz, 40Hz

3 Scene

Automatically applies scene information to the UR22C device when loading a Cubase project file containing UR22C scene data.

NOTICE

Data saved to the device will be overwritten.

4 Channel Link

Automatically configures stereo links based on the bus configuration in use.

Sweet Spot Morphing Channel Strip

The Sweet Spot Morphing Channel Strip (“Channel Strip” for short) is a multi-effect that combines compression and EQ. Advanced sound engineering know-how is condensed into a number of convenient presets that can be simply and instantly recalled, for professional results.

Two channel strips are provided, and each can be assigned to the monitor sound only, or to both the monitor and recorded sound.

The Channel Strip equipped with the device and the Channel Strip of the VST Plug-in version have the same parameters. When using the Channel Strip on Cubase series programs, you can share the settings between the built-in Channel Strip and the Channel Strip of the VST Plug-in version as a preset file. Also, when assigning the Channel Strip of the VST Plug-in version to the effect slot on Cubase series programs, select it from the [Dynamics] category (in the case of the default settings).

Screenshot



How to Open the Window

From Dedicated Windows for Cubase Series

Select the “Channel Strip” from the “Effect Type”, then click “Channel Strip Edit” in the section “Input Settings Window” (page 14).

From dspMixFx UR-C

Select the “Channel Strip” from the “Effect Type”, then click “Channel Strip Edit” in the section “Channel Area” (page 9).

Common to Compressor and Equalizer



1 MORPH

Adjusts the parameter of the Sweet Spot Data. You can simultaneously adjust the compressor and equalizer settings which are set to five points around this knob by turning this knob. When you set the knob between two adjacent points, the compressor and equalizer settings will be set to an intermediate value.

2 Sweet Spot Data

Selects the Sweet Spot Data.

3 TOTAL GAIN

Adjusts the total gain of the Channel Strip.

Range: -18.0 dB – +18.0 dB

4 Level Meter

Indicates the output level of the Channel Strip.

Compressor



1 ATTACK

Adjusts the attack time of the compressor.

Range: 0.092 msec – 80.00 msec

2 RELEASE

Adjusts the release time of the compressor.

Range: 9.3 msec – 999.0 msec

3 RATIO

Adjusts the release time of the compressor.

Range: 1.00 – ∞

4 KNEE

Selects the knee type of the compressor.

Settings	Description
SOFT	Produces the most gradual change.
MEDIUM	Results in a setting midway between SOFT and HARD.
HARD	Produces the sharpest change.

5 SIDE CHAIN Q

Adjusts the band width of the side chain filter.

Range: 0.50 – 16.00

6 SIDE CHAIN F

Adjusts the center frequency of the side chain filter.

Range: 20.0 Hz – 20.0 kHz

7 SIDE CHAIN G

Adjusts the gain of the side chain filter.

Range: -18.0 dB – +18.0 dB

8 COMPRESSOR On/Off

Turns the compressor on (lit) and off (unlit).

9 Compressor Curve

This graph indicates the approximate compressor response. The vertical axis indicates the output signal level, and the horizontal axis indicates the input signal level.

10 Gain Reduction Meter

Indicates the gain reduction.

11 DRIVE

Adjusts the degree to which the compressor is applied. The higher the value, the greater the effect.

Range: 0.00 – 10.00

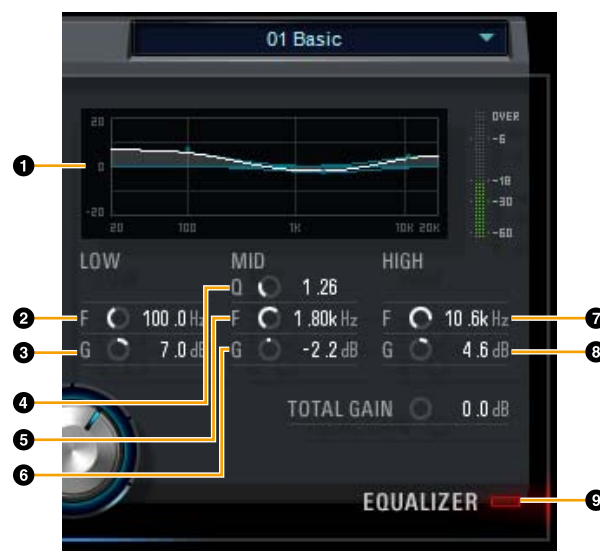
Equalizer**1 Equalizer Curve**

This graph indicates the characteristics of the 3-band equalizer. The vertical axis indicates the gain, and the horizontal axis indicates the frequency. You can adjust LOW, MID, and HIGH by dragging each handle in the graph.

2 LOW F

Adjusts the center frequency of the low band.

Range: 20.0 Hz – 1.00 kHz

3 LOW G

Adjusts the gain of the low band.

Range: -18.0 dB – +18.0 dB

4 MID Q

Adjusts the band width of the middle band.

Range: 0.50 – 16.00

5 MID F

Adjusts the center frequency of the middle band.

Range: 20.0 Hz – 20.0 kHz

6 MID G

Adjusts the gain of the middle band.

Range: -18.0 dB – +18.0 dB

7 HIGH F

Adjusts the center frequency of the high band.

Range: 500.0 Hz – 20.0 kHz

8 HIGH G

Adjusts the gain of the high band.

Range: -18.0 dB – +18.0 dB

9 EQUALIZER On/Off

Turns the equalizer on (lit) and off (unlit).

REV-X

REV-X is a digital reverb platform developed by Yamaha for pro audio applications.

One REV-X effect is included in this unit. Input signals can be sent to the REV-X effect, and the REV-X effect is applied only to the monitor outputs. Three types of REV-X are available: Hall, Room, and Plate. The hardware REV-X equipped with the device and REV-X of the VST Plug-in version have essentially the same parameters. However, the [OUTPUT] and [MIX] parameters are only available in the VST Plug-in version.

When using REV-X on Cubase series programs, you can share the settings between the built-in REV-X and REV-X of the VST Plug-in version as a preset file. Also, when assigning REV-X of the VST Plug-in version to the effect slot on Cubase series programs, select it from the [Reverb] category (in the case of the default settings).

The built-in REV-X is equipped with an “FX Bus” which is used for sending the signal from DAW software to REV-X. For example, to send the recorded audio data to REV-X, you can check the sound with REV-X, which is used for monitoring during the recording.

Screenshot

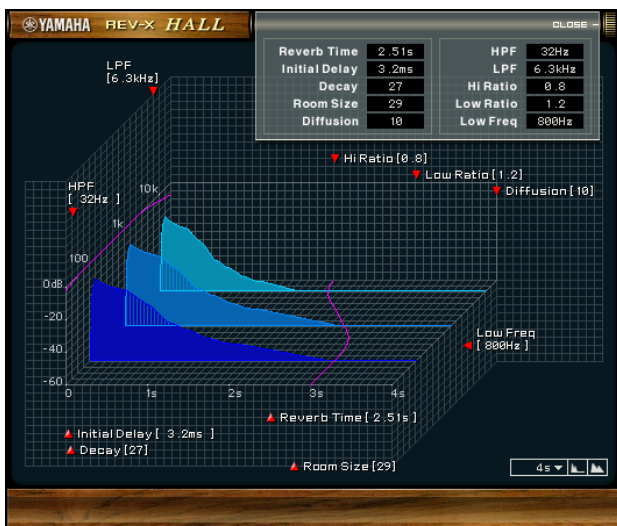

How to Open the Window

From Dedicated Windows for Cubase Series

Click “REV-X Edit” (page 14) in the section “Reverb Routing Window.”

From dspMixFx UR-C

Click “REV-X Edit” (page 10) in the section “Master Area.”

REV-X

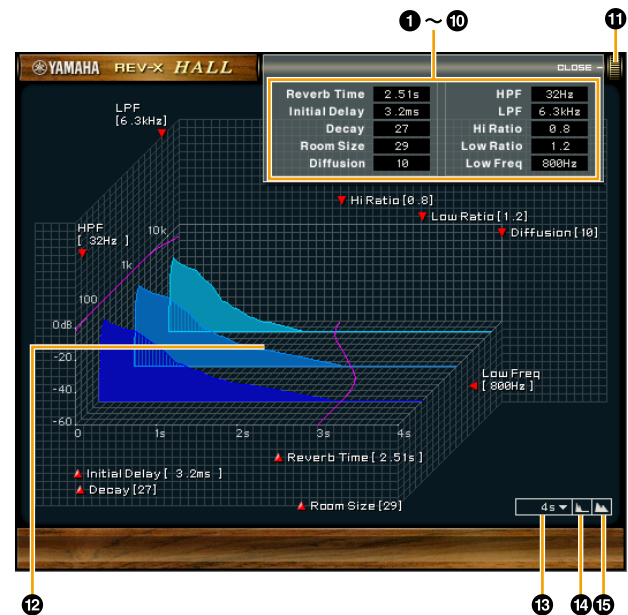

This section uses the Hall type of REV-X as an example.

1 Reverb Time

Adjusts the reverb time. This parameter links to Room Size. The adjustable range varies depending on the REV-X type.

REV-X type	Range
Hall	0.103 sec – 31.0 sec
Room	0.152 sec – 45.3 sec
Plate	0.176 sec – 52.0 sec

2 Initial Delay

Adjusts the time that elapses between the direct, original sound and the initial reflections that follow it.

Range: 0.1 msec – 200.0 msec

3 Decay

Adjusts the characteristic of the envelope from the moment the reverberation starts to the moment it attenuates and stops.

Range: 0 – 63

4 Room Size

Adjusts the size of the simulated room. This parameter links to Reverb Time.

Range: 0 – 31

5 Diffusion

Adjusts the spread of the reverberation.

Range: 0 – 10

6 HPF

Adjusts the cutoff frequency of the high pass filter.

Range: 20 Hz – 8.0 kHz

7 LPF

Adjusts the cutoff frequency of the low pass filter.

Range: 1.0 kHz – 20.0 kHz

8 Hi Ratio

Adjusts the duration of reverberation in the high frequency range by using a ratio relative to the Reverb Time. When you set this parameter to 1, the actual specified Reverb Time is fully applied to the sound. The lower the value, the shorter the duration of reverberation in the high frequency range.

Range: 0.1 – 1.0

9 Low Ratio

Adjusts the duration of reverberation in the low frequency range by using a ratio relative to the Reverb Time. When you set this parameter to 1, the actual specified Reverb Time is fully applied to the sound. The lower the value, the shorter the duration of reverberation in the low frequency range.

Range: 0.1 – 1.4

10 Low Freq

Adjusts the frequency of the Low Ratio.

Range: 22.0 Hz – 18.0 kHz

11 OPEN/CLOSE

Opens and closes the window for adjusting the reverb settings.

12 Graph

Indicates the characteristics of reverberation. The vertical axis indicates the signal level, the horizontal axis indicates the time, and the Z-axis indicates the frequency. You can adjust the characteristics of reverberation by dragging the handles in the graph.

13 Time Axis Setting

Select the display range of the time (horizontal axis) on the graph.

Display range: 500 msec – 50 sec

14 Zoom Out

Zooms out the display range of the time (horizontal axis) on the graph.

15 Zoom In

Zooms in the display range of the time (horizontal axis) on the graph.

Software operation

- You can reset certain parameters to their default values by holding the [Ctrl]/[command] key while you click on the appropriate knobs, sliders, and faders.
- You can adjust the parameters more finely by holding the [SHIFT] key while you drag on the appropriate knobs, sliders, and faders.

Guitar Amp Classics

Guitar Amp Classics are guitar amp simulations that make extensive use of advanced Yamaha modeling technology. Four amp types with different sonic characteristics are provided.

The Guitar Amp Classics equipped with the device and the Guitar Amp Classics of the VST Plug-in version have the same parameters. When using the Guitar Amp Classics on Cubase series programs, you can share the settings between the built-in Guitar Amp Classics and the Guitar Amp Classics of the VST Plug-in version as a preset file. Also, when assigning the Guitar Amp Classics of the VST Plug-in version to the effect slot on Cubase series programs, select it from the [Distortion] category (in the case of the default settings). Note that Guitar Amp Classics equipped with the device cannot be used when the sample rate is set to 176.4 kHz or 192 kHz.

Screenshot



How to Open the Window

From Dedicated Windows for Cubase Series

Select the “Guitar Amp Classics” from the “Effect Type”, then click “Effect Edit” in the section “Input Settings Window” ([page 14](#)).

From dspMixFx UR-C

Select the “Guitar Amp Classics” from the “Effect Type”, then click “Effect Edit” in the section “Channel Area” ([page 9](#)).

CLEAN



This amp type is optimized for clean tones, effectively simulating the tight brilliance of transistor amplifiers. The tonal character of this amp model provides an ideal platform for recording with multi-effects. It also features built-in chorus and vibrato effects.

1 VOLUME

Adjusts the amplifier’s input level.

2 DISTORTION

Adjusts the depth of distortion produced.

3 TREBLE/MIDDLE/BASS

These three controls adjust the amplifier’s tonal response in the high, middle, and low frequency ranges.

4 PRESENCE

Can be adjusted to emphasize the high frequencies and overtones.

5 Cho/OFF/Vib

Turns the Chorus or Vibrato effect on or off. Set to [Cho] to turn the Chorus effect on, or to [Vib] to turn the Vibrato effect on.

6 SPEED/DEPTH

These controls adjust the speed and depth of the Vibrato effect when it is on. The SPEED and DEPTH controls only work with the Vibrato effect, and are disengaged when the Cho/OFF/Vib control, above, is set to “Cho” or “OFF.”

7 BLEND

Adjusts the balance between the direct and effect sound.

8 OUTPUT

Adjusts the final output level.

CRUNCH



This is the amp type to use when you want lightly overdriven crunch tones. The CRUNCH model simulates the type of vintage tube amplifiers that are favored for blues, rock, soul, R&B, and similar styles.

1 Normal/Bright

Selects a normal or bright tonal character. The [Bright] setting emphasizes the high-frequency overtones.

2 GAIN

Adjusts the input level applied to the preamp stage. Rotate clockwise to increase the amount of overdrive produced.

3 TREBLE/MIDDLE/BASS

These three controls adjust the amplifier's tonal response in the high, middle, and low frequency ranges.

4 PRESENCE

Can be adjusted to emphasize the high frequencies and overtones.

5 OUTPUT

Adjusts the final output level.

DRIVE



The DRIVE amp type provides a selection of distortion sounds that simulate the tonal character of various high gain tube amplifiers. From mildly overdriven crunch to heavy distortion suitable for hard rock, heavy metal, or hardcore styles, this model offers a wide range of sonic capabilities.

1 AMP TYPE

Six amplifier types are provided. Types 1 and 2 feature relatively mild distortion that allows picking nuances to come through naturally. Types 3 and 4 have more pronounced overtones, resulting in a fat, soft tone. Types 5 and 6 deliver wilder, aggressive distortion with a tight attack. The even-numbered amp types have greater presence and range than the odd-numbered types.

2 GAIN

Adjusts the input level applied to the preamp stage. Rotate clockwise to increase the amount of distortion produced.

3 MASTER

Adjusts the output level from the preamp stage.

4 TREBLE/MIDDLE/BASS

These three controls adjust the amplifier's tonal response in the high, middle, and low frequency ranges.

5 PRESENCE

Can be adjusted to emphasize the high frequencies and overtones.

6 OUTPUT

Adjusts the final output level.

LEAD



The LEAD amp type simulates a high-gain tube amp that is rich in overtones. It is ideally suited to playing lead guitar lines that will project well in an ensemble, but it can also be set up for crisp accompaniment tones as well.

1 High/Low

Selects the amp output type. The [High] setting simulates a high-output amp, and allows the creation of more distorted tones.

2 GAIN

Adjusts the input level applied to the preamp stage. Rotate clockwise to increase the amount of distortion produced.

3 MASTER

Adjusts the output level from the preamp stage.

4 TREBLE/MIDDLE/BASS

These three controls adjust the amplifier's tonal response in the high, middle, and low frequency ranges.

5 PRESENCE

Used to emphasize the high frequencies and overtones.

6 OUTPUT

Adjusts the final output level.

Using the GAIN, MASTER, and OUTPUT Controls

The tonal character of the DRIVE and LEAD amp types can be adjusted over a wide range via the GAIN, MASTER, and OUTPUT controls. GAIN adjusts the level of the signal applied to the preamp stage, affecting the amount of distortion produced. MASTER adjusts the output level from the preamp stage that is then fed to power amp stage. The GAIN and MASTER control settings have a large effect on the final sound, and the MASTER control may need to be turned up fairly high in order to drive the power stage sufficiently for optimum tone. The OUTPUT control adjusts the final output level from the amp model without affecting the distortion or tone, and is useful for adjusting the guitar's volume without changing any other aspects of the sound.

Using with a Computer

Connection Example

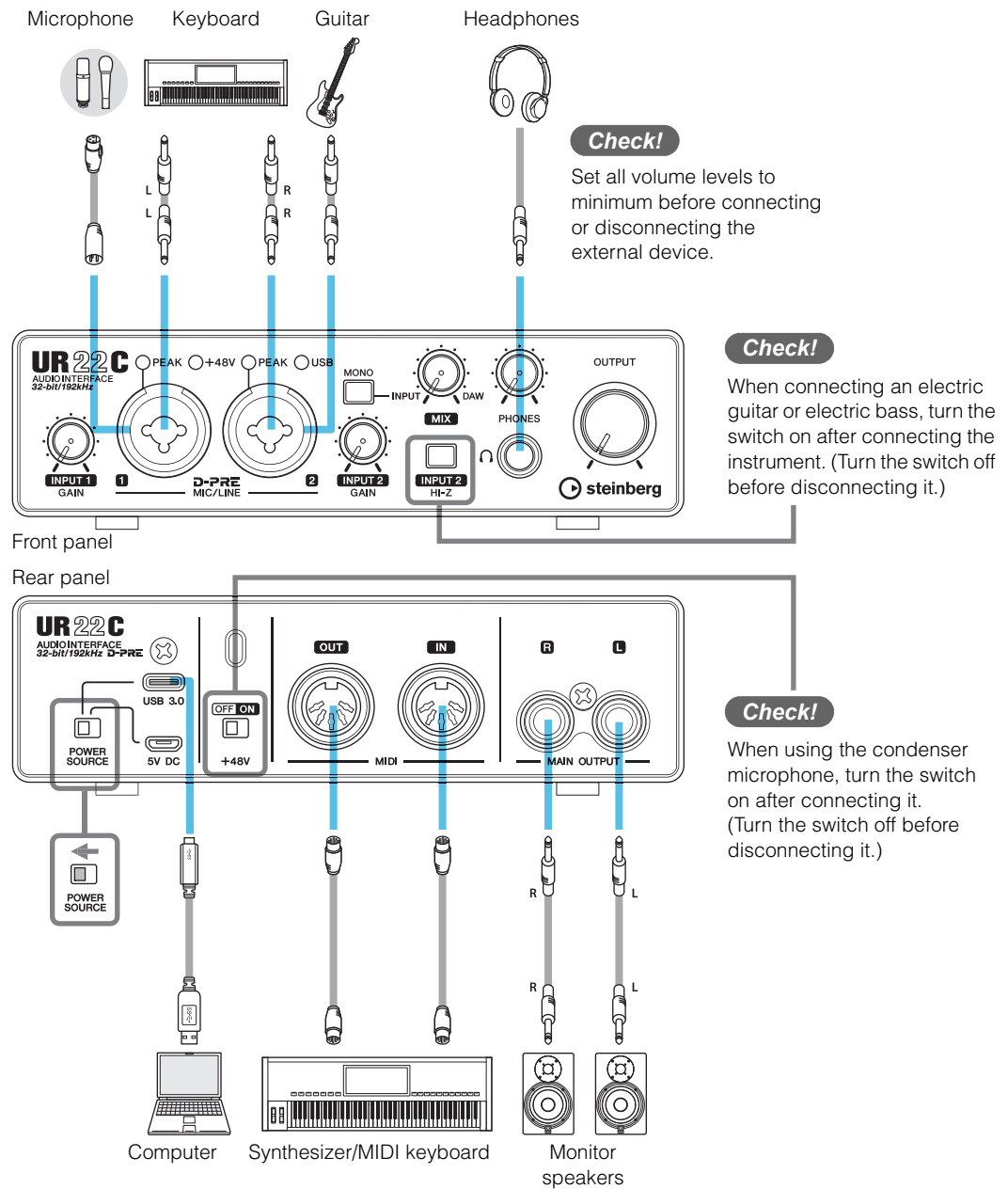

NOTE

- When using the device with bus power supply, connect it to the USB 3.0 port of the computer.
- For the connector type of the computer to be connected to the device, refer to "Connector type of a computer" (page 33).

Configuring Audio Driver Settings on the DAW Software

Cubase Series Programs

1. **Make sure that all applications have been closed.**
2. **Connect the device directly to the computer by using the included USB cable.**
3. **Confirm the [USB] indicator is lit.**
4. **Double-click the shortcut of Cubase series on the desktop to start Cubase.**
5. **When the [ASIO Driver Setup] window appears while the Cubase series program is launching, confirm that the device is selected, then click [OK].**

NOTE

When [Steinberg UR22C (High Precision)] is selected on Mac, Cubase will exclusively use the driver. In this condition, [Steinberg UR22C] cannot be used by other applications.

The audio driver settings are now complete.

Programs other than Cubase Series

1. **Make sure that all applications have been closed.**
2. **Connect the device directly to the computer by using the included USB cable.**
3. **Confirm the [USB] indicator is lit.**
4. **Launch the DAW software.**
5. **Open the audio interface settings window.**
6. **(Windows only) Select the ASIO Driver for the audio driver settings.**
7. **Set the ASIO Driver for Windows and audio interface for Mac as follows.**

Windows

Set the [Yamaha Steinberg USB ASIO] to the ASIO Driver settings.

Mac

Set the UR22C to the audio interface settings.

The audio driver settings are now complete.

Recording/Playback

This section explains simple recording operations for using a microphone. Connect a microphone to [MIC/LINE 1] jack as shown in the connection examples (page 23). Turn the [+48V] switch on when using a phantom powered condenser microphone.

Cubase Series Programs

1. Launch the Cubase series DAW and display the [steinberg hub] window.
2. Select the template [Empty] in [Recording] on the [steinberg hub] window, then click [Create].
3. Turn on Direct Monitoring as follows.
[Studio] → [Studio Setup] → [Yamaha Steinberg USB ASIO] (Windows) or [Steinberg UR22C] (Mac) → enter checkmark to [Direct Monitoring] → [OK]
4. Return to the project window and click [Project] → [Add Track] → [Audio] to display [Add Track].
5. Select the [Audio Inputs] and [Configuration] to [Mono] and [Count] to [1], and then click [Add track] to create one new audio track.

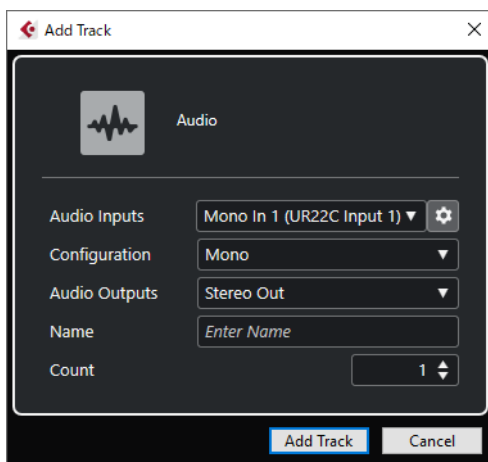

6. Confirm that the [Record Enable] and [Monitor] indicators are turned on (lit) for the added audio track.



7. While singing into the microphone, adjust the input signal level of the microphone with the [INPUT 1 GAIN] knob on the device.

Setting optimum recording levels

Adjust the [INPUT GAIN] knobs so that the [PEAK] indicator flashes briefly at the loudest input volume.

8. While singing into the microphone, adjust the output signal level of the headphones with the [PHONES] knob on the device.
9. Click  to start the recording.



10. After finishing the recording, click  to stop it.



11. Turn [Monitor] off (unlit) for the just recorded audio track.



12. Click the Ruler to move the project cursor to the desired point for starting playback.

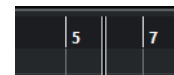

13. Click  to check the recorded sound.

When listening to the sound over monitor speakers, adjust the output signal level by the [OUTPUT] knob on the device.



The recording and playback operations are now complete.

For more detailed instructions on using Cubase series programs, refer to the Cubase operation manual.

Programs other than Cubase Series

1. **Launch your DAW software.**
2. **Open dspMixFx UR-C.**
For instructions on how to open dspMixFx UR-C, refer to the section “How to Open the Window” (page 8).
3. **Adjust the input signal level of the microphone with the [INPUT GAIN] knob on the device.**

Setting optimum recording levels

Adjust the [INPUT GAIN] knobs so that the [PEAK] indicator flashes briefly at the loudest input volume.

4. **While singing into the microphone, adjust the output signal level of the headphones with the [PHONES] knob on the device.**
5. **Set the Channel Strip settings and REV-X settings on dspMixFx UR-C.**
6. **Start recording on your DAW software.**
7. **After finishing recording, stop it.**
8. **Playback the newly recorded sound to check it.**

For more detailed instructions on using the DAW software, refer to your particular DAW’s software manual.

Using with an iOS Device

Connection Example

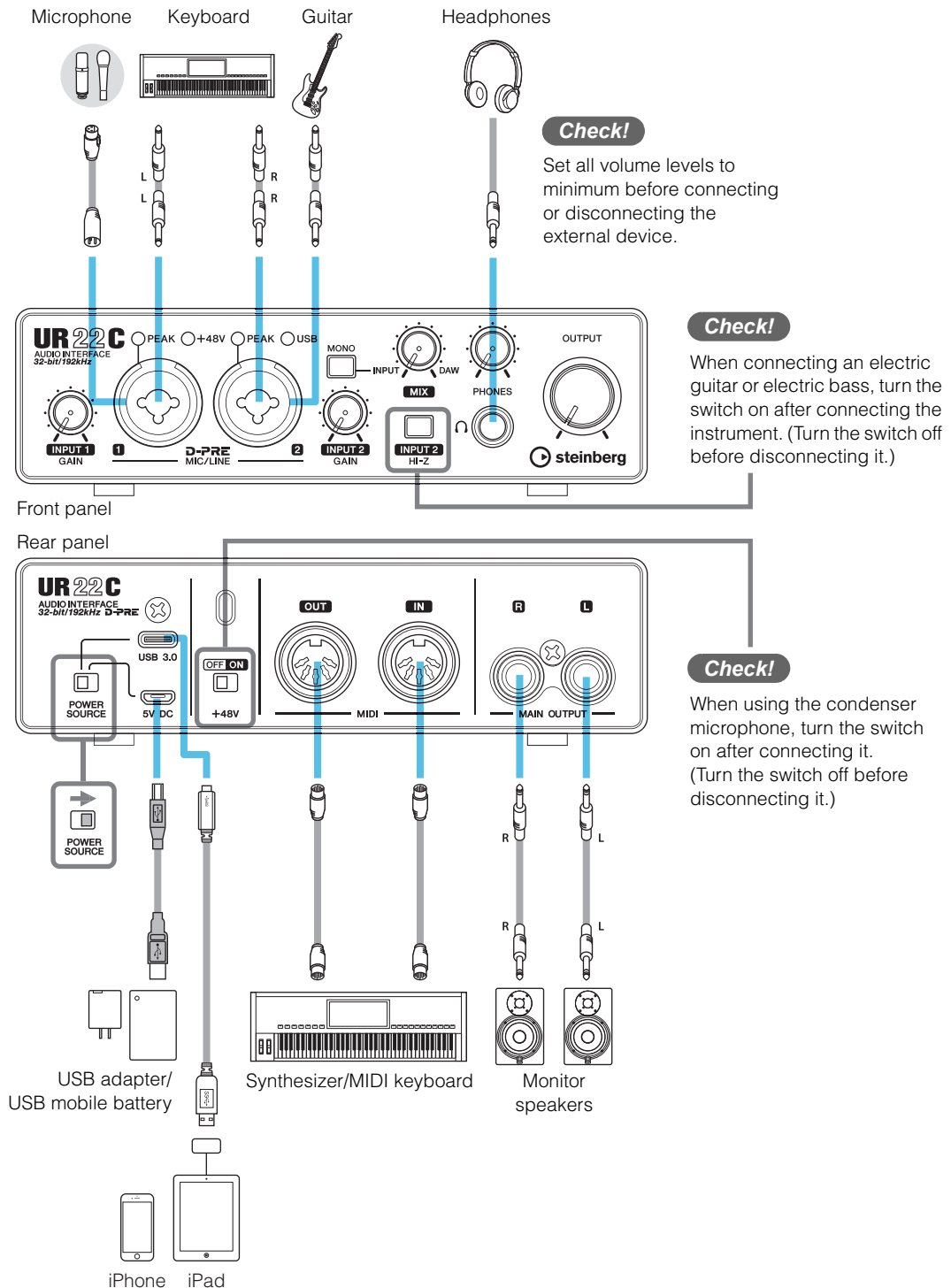

NOTE

- Apple accessories may be required when connecting the UR22C with iOS devices. For details, refer to the UR22C Startup Guide.
- For iOS devices, it is necessary to supply power from the USB power adapter or a USB mobile battery.
- For the latest information on compatible iOS devices, refer to the Steinberg website below.
<https://www.steinberg.net/>

Recording/Playback

This section explains simple recording operations for using a microphone. Connect a microphone to [MIC/LINE 1] jack as shown in the connection examples (page 27). Turn the [+48V] switch on when using a phantom powered condenser microphone.

The explanation uses Cubasis (DAW app) as an example.

NOTE

- iOS app may not be supported in your area. Please check with your Yamaha dealer.
- For the latest Cubasis information, see the Steinberg web site below.
<https://www.steinberg.net/>

1. **Open Cubasis.**
2. **Tap the [MEDIA] tab on the upper left of the screen.**

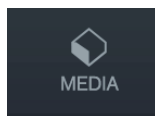

[Create New Project] is shown in the bottom of the screen.

Create New Project [Template]

3. **Tap the [Create New Project].**
4. **Enter a project name and tap [OK] in the [New project] window.**

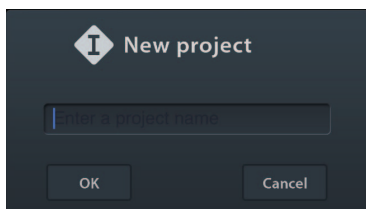

5. **Tap [+ADD] on the left of the screen, then tap [AUDIO] to add an Audio Track.**

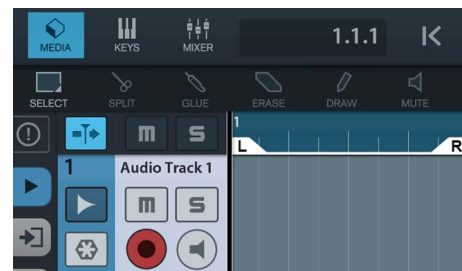
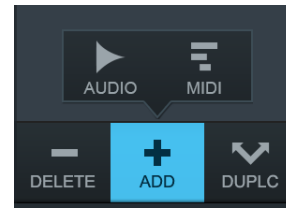

6. **Tap [Inspector] on the far left of your screen to show the track inspector.**

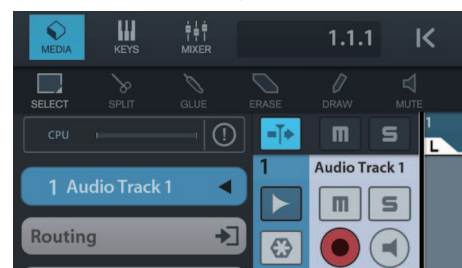
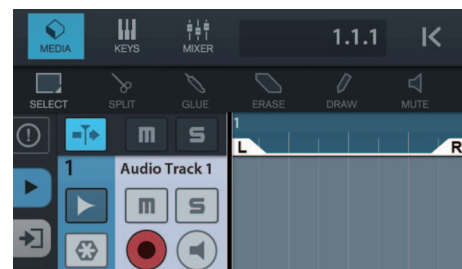

7. **Tap [Input Bus] to show the details window and set the input bus for the track by tapping a number.**
8. **Tap [Monitoring] to turn monitoring on (lit).**
9. **Adjust the input signal level of the microphone with the [INPUT 1 GAIN] knob on the device.**

Setting optimum recording levels

Adjust the [INPUT GAIN] knobs so that the [PEAK] indicator flashes briefly at the loudest input volume.

10. While singing into the microphone, adjust the output signal level of the headphones with the [PHONES] knob on the device.

11. Tap [●] to start the recording.

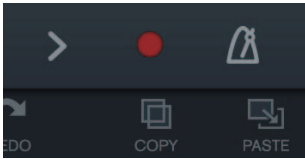

12. Tap [>] to stop the recording.

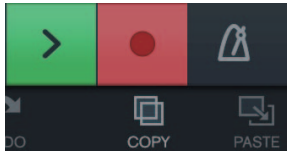

13. Tap and slide on the ruler to move the playback position.

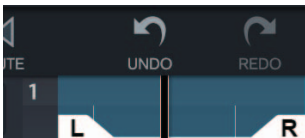

You can also tap [◀] to return the beginning of the recording.

14. Tap [>] to playback the recorded sound.

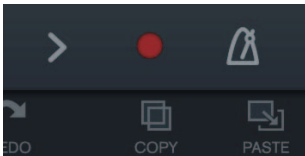

dspMixFx (for iOS devices)

From your iOS devices, you can conveniently control built-in DSP mixer functions and DSP effects by using dspMixFx for iOS devices. For details on this app, see the Steinberg web site below.

<https://www.steinberg.net/>

Troubleshooting

<p>The power indicator is off</p>	<p>Is the [POWER SOURCE] switch set properly? The power indicator does not light when power is not supplied to the device. Move the [POWER SOURCE] switch to the [5V DC] jack side when using AC adapter or move the switch to [USB 3.0] jack side for bus-powered supply (computer only).</p>
<p>The power indicator flashes continuously</p>	<p>Is there a problem with power supply? The indicator flashes continuously If the power supply is insufficient. Move the [POWER SOURCE] switch to [5V DC] jack side and use the USB power adaptor or USB mobile battery for the power supply.</p>
	<p>Confirm whether or not a proper USB cable is used.</p> <ul style="list-style-type: none"> • Make sure to use the included USB cable. • For a connecting the device to the USB Type-C port of a computer, use a commercially available USB 3.1 Type -C to Type-C cable.
<p>The USB indicator flashes continuously</p>	<p>Has TOOLS for UR-C been installed properly? (Computer only) The indicator flashes continuously when the computer or iOS device does not recognize the device. Refer to the Startup Guide instructions to complete the TOOLS for UR-C installation.</p>
<p>No Sound</p>	<p>Has TOOLS for UR-C been installed properly? (Computer only) Refer to the Startup Guide instructions to complete the TOOLS for UR-C installation.</p>
	<p>Confirm that a proper USB cable is being used. Make sure to use the included USB cable.</p>
	<p>Are the volume controls of the device set to appropriate levels? Confirm the levels of the [OUTPUT] knob and [PHONES] knob.</p>
	<p>Are the microphones and monitor speakers connected to the device properly? Refer to the section “Connection Examples” (pages 23, 27) to confirm the connection.</p>
	<p>Are the audio driver settings on DAW software set properly? Refer to the section “Configuring the Audio Driver Settings on DAW Software” (page 24) to set it.</p>

No Sound

Is the [ASIO Driver] setting on the Cubase series program set properly?

From the Cubase series menu, open the [Studio] → [Studio Setup] → [VST Audio System], then confirm that the [Yamaha Steinberg USB ASIO] (Windows) or [Steinberg UR22C] or [Steinberg UR22C (High Precision)] (Mac) is selected on the [ASIO Driver].

Windows

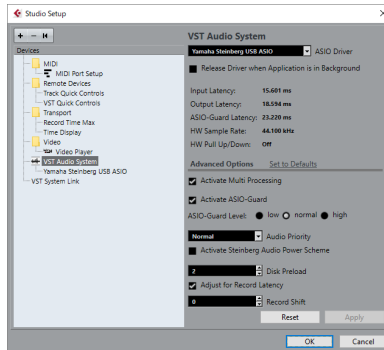

Mac

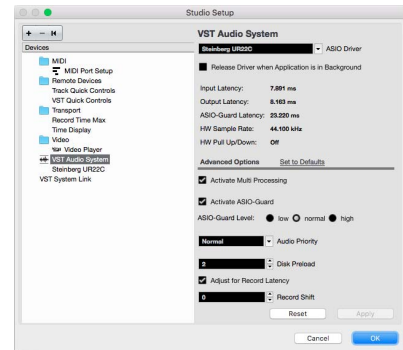

Was the power of the device turned on before starting the DAW software?

Before starting the DAW software, connect the device to a computer and turn on the power of the device.

Is the input/output routing set properly?

Refer to the section “Recording/Playback” (page 25) to check the input/output routing in the DAW.

Is the monitor speaker switch turned on?

Confirm that the monitor speaker switch is turned on.

Is the buffer size set too low?

Increase the buffer size compared to the current settings; refer to the section “Yamaha Steinberg USB Driver” (page 6) for instructions.

Is the error message “Audio Format is Unmixable” shown? (Mac only)

The error message “Audio Format is Unmixable” is shown in the Yamaha Steinberg USB control panel. Click [Revert to Mixable] to resolve the error.

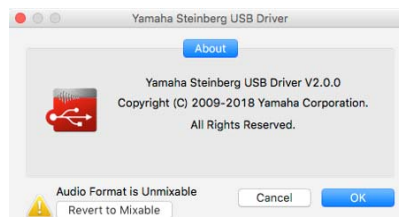

Unusual sound (noise, interruption, or distortion)	Does your computer satisfy the system requirements? Confirm the system requirements. For the latest information, see the Steinberg website below. https://www.steinberg.net/
	Is the USB Mode set properly? Depending on the USB host controller in your computer, audio dropout might occur when SuperSpeed (USB 3.1 Gen1) mode is used. In such a case, please try switching to High-Speed (USB 2.0) mode in the Yamaha Steinberg USB Driver Control Panel.
	Are you recording or playing long continuous sections of audio? The audio data processing capabilities of your computer will depend on a number of factors including CPU speed and access to external devices. Reduce the audio tracks and check the sound again.
	Are the microphones properly connected to the device? Connect a microphone with an XLR plug to the device. If you use a phone plug, the volume may be insufficient.
	Is the loopback function set properly? Set Enable Loopback to off when not using the Loopback function. For instructions, refer to the section "Settings Window" (page 11).
	Is the error message "Audio Format is Unmixable" shown? (Mac only) The error message "Audio Format is Unmixable" is shown in the Yamaha Steinberg USB control panel. Click [Revert to Mixable] to resolve the error.

For the latest support information, refer to the Steinberg website below.

<https://www.steinberg.net/>

Appendix

Limitations on the use of effects

Two Channel Strips and one Guitar Amp Classics are provided in the UR22C.

Simultaneous use of the Channel Strips and Guitar Amp Classics on the same channel is possible since two slots are provided for inserting effects in to each input channel.

However, the following restrictions apply.

- Two Channel Strips and two Guitar Amp Classics cannot be used in the same channel.
- Guitar Amp Classics cannot be used in stereo channels.
- Guitar Amp Classics cannot be used when the sample rate is set to 176.4 kHz or 192 kHz.

Computer connector types

USB 3.0 Type A

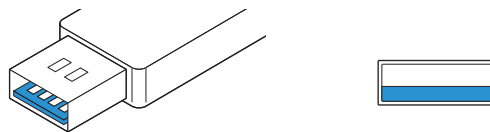

When connecting the device to a USB 3.0/2.0 Type -A port of the computer, you will need the included USB cable and AC adaptor.

USB 2.0 Type A

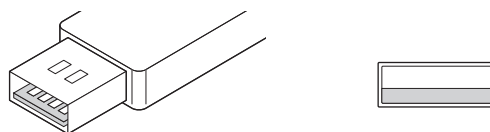

When connecting the device to a USB 3.0/2.0 Type-A port of the computer, you will need the included USB cable and a commercially available USB power adapter or USB mobile battery.

USB 3.1 Type C

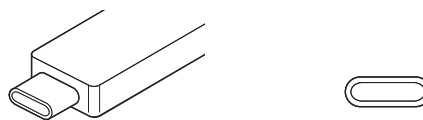

When connecting the device to a USB 3.1 Type C port, you will need a commercially available USB 3.1 Type-C to Type-C cable (optional). Bus power operation is possible in this case.

Signal Flows

The following chart indicates the signal flow in the device.

NOTE

- The controllers on the device, such as the [INPUT GAIN] knobs, [OUTPUT] knob are not included in this chart.
- To configure each parameter, use the “dspMixFx UR-C” (page 8) or “Dedicated Windows for Cubase Series” (page 13).
- Please note that you cannot use the built-in Guitar Amp Classics when the sample rate is set to 176.4 kHz or 192 kHz.

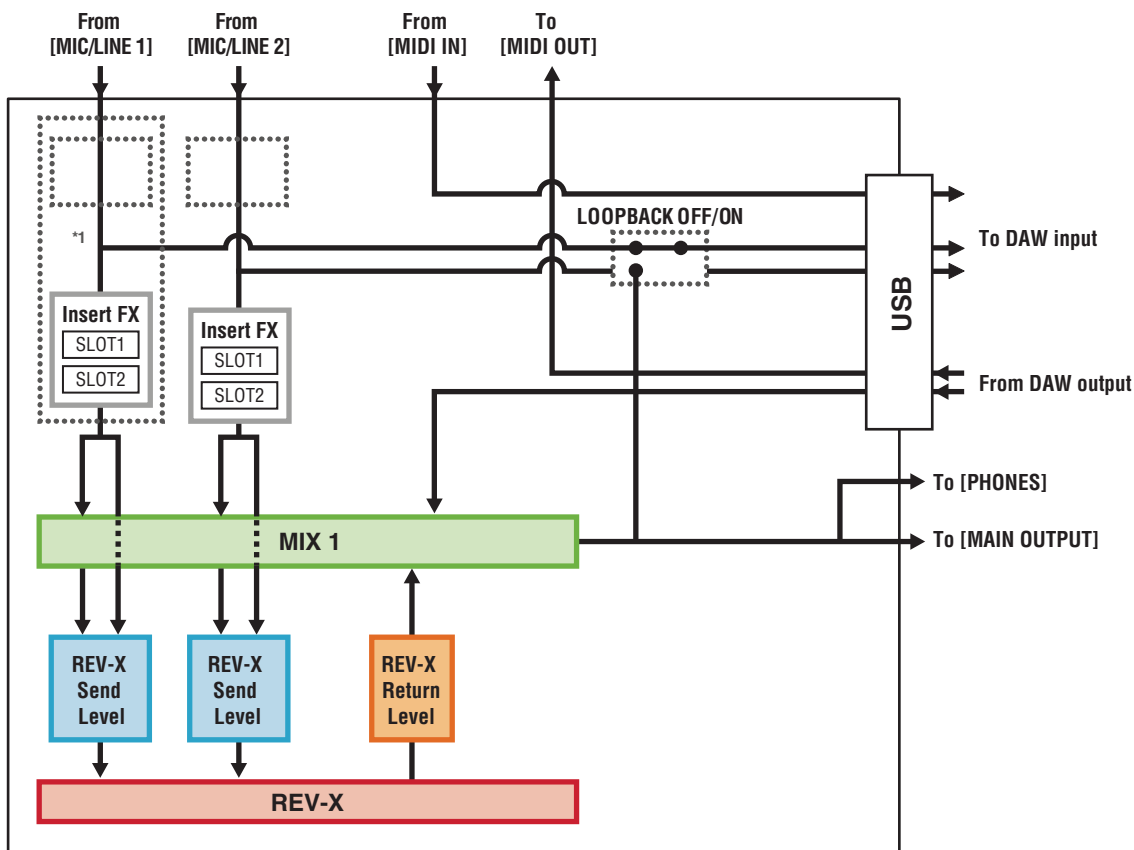

*1 The following chart indicates an effect insertion location.

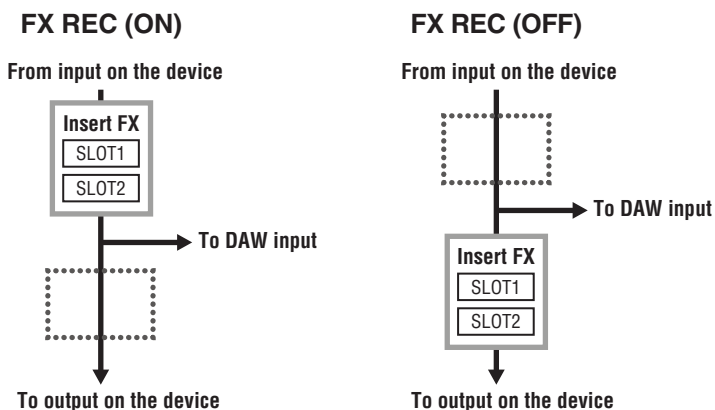

- Set FX REC ON when recording the DSP effect processed signal with the DAW.
- Set FX REC OFF when recording a signal without DSP effect processing with the DAW.

Block Diagrams

44.1kHz, 48kHz, 88.2kHz, 96kHz

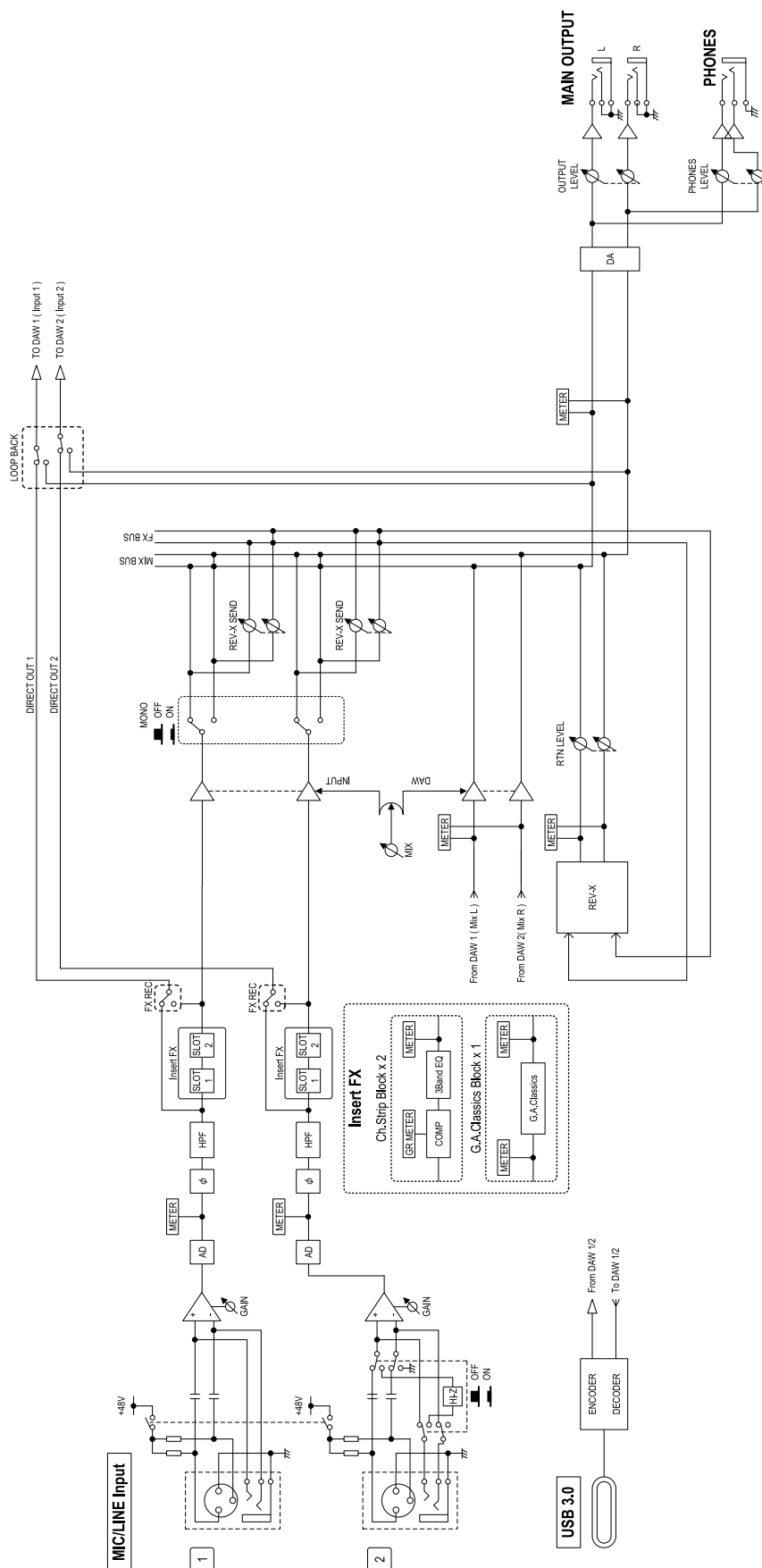

176.4kHz, 192kHz

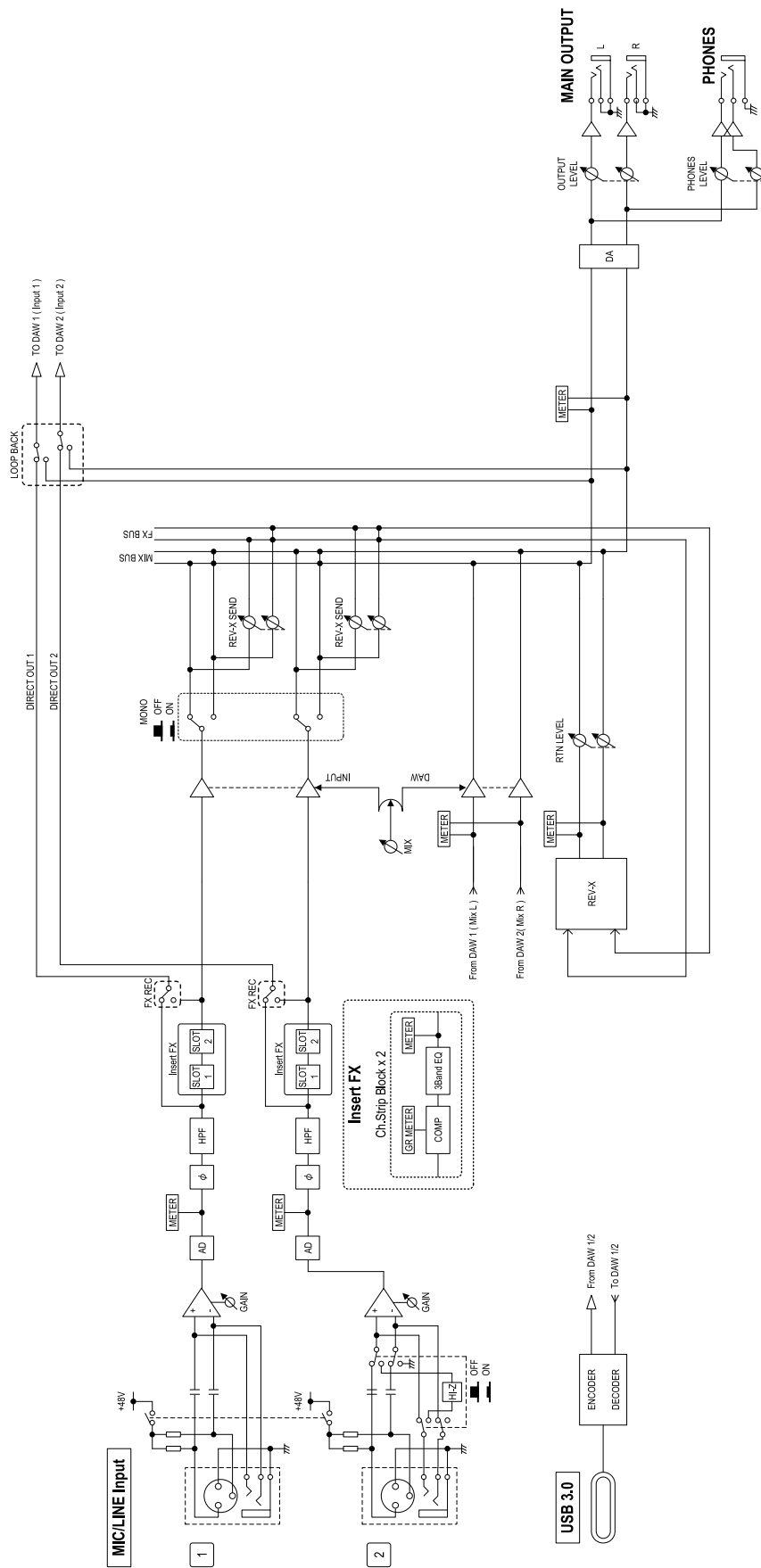

Technical Specifications

MIC INPUT 1-2 (balanced)	
Frequency Response	+0.0/-0.3 dB, 20 Hz – 22 kHz
Dynamic Range	102 dB, A-Weighted
THD+N	0.003%, 1 kHz, -3 dBFS, 22 Hz/22 kHz BPF
Maximum Input Level	+6 dBu
Input Impedance	4 k Ω
Gain Range	+6 dB – +60 dB
HI-Z INPUT 2 (unbalanced)	
Maximum Input Level	+9.0 dBV
Input Impedance	1 M Ω
Gain Range	0 dB – +54 dB
LINE INPUT 1/2 (balanced)	
Maximum Input Level	+24 dBu
Input Impedance	18.5 k Ω
Gain Range	-12 dB – +42 dB
MAIN OUTPUT (Impedance balanced)	
Frequency Response	+0.0/-0.2 dB, 20 Hz – 22 kHz
Dynamic Range	106 dB, A-Weighted
THD+N	0.0015%, 1 kHz, -1 dBFS, 22 Hz/22 kHz BPF
Maximum Output Level	+12 dBu
Output Impedance	150 Ω
PHONES	
Maximum Output Level	15 mW +15 mW, 40 Ω
USB	
Specification	USB 3.0, 32-bit, 44.1 kHz/48 kHz/88.2 kHz/96 kHz/176.4 kHz/192 kHz
XLR INPUT	
Polarity	 1: Ground 2: Hot (+) 3: Cold (-)

General Specifications

Power Requirements	4.5 W
Dimensions (W x H x D)	159 x 47 x 159 mm
Net Weight	1.0 kg
Operating Free-air Temperature Range	0 – 40 °C
Included Accessories	<ul style="list-style-type: none"> • USB 3.0 cable (3.1 Gen1, Type-C to Type-A, 1.0 m) • Startup Guide • CUBASE AI DOWNLOAD INFORMATION • ESSENTIAL PRODUCT LICENCE INFORMATION

The contents of this manual apply to the latest specifications as of the publishing date.

To obtain the latest manual, access the Steinberg website then download the manual file.

Uninstalling TOOLS for UR-C

To uninstall the software, you must remove the following software one by one.

- Yamaha Steinberg USB Driver
- Steinberg UR-C Applications
- Basic FX Suite

Follow the steps below to uninstall TOOLS for UR-C.

Windows

- 1. Disconnect all USB devices other than the mouse and keyboard from the computer.**
- 2. Start the computer and log on to the Administrator account.**
Exit any open applications and close all open windows.
- 3. Open the window for the uninstall operation as follows.**
[Control Panel] → [Uninstall a Program] to call up the [Uninstall or change a program] panel.
- 4. Select the software to be uninstalled from the list.**
 - Yamaha Steinberg USB Driver
 - Steinberg UR-C Applications
 - Basic FX Suite
- 5. Click the [Uninstall] / [Uninstall /Change].**
If the [User Account Control] window appears, click [Continue] or [Yes].
- 6. Follow the on-screen instructions to remove the software.**

Repeat steps 4 through 6 to uninstall the remaining software you have not selected.

Uninstalling TOOLS for UR-C is now complete.

Mac

- 1. Disconnect all USB devices other than the mouse and keyboard from the computer.**
- 2. Start the computer and log in to the Administrator account.**
Exit any open applications and close all open windows.
- 3. Extract the TOOLS for UR-C that you downloaded in advance.**
- 4. Double-click the following file in the extracted folder.**
 - Uninstall Yamaha Steinberg USB Driver
 - Uninstall Steinberg UR-C Applications
 - Uninstall Basic FX Suite
- 5. Click [Run] when the “Welcome to the ***uninstaller.” message appears.**
The characters *** represent the software name. After that, follow the onscreen instructions to uninstall the software.
- 6. Click [Restart] or [Close] when the “Uninstallation completed.” message appears.**
- 7. When the message prompting you to restart your computer appears, click [Restart].**

Repeat steps 4 through 7 to uninstall the remaining software you have not selected.

Uninstalling TOOLS for UR-C is now complete.

Steinberg Website
<https://www.steinberg.net/>

Manual Development Group
© 2019 Yamaha Corporation
Published 08/2019 MW-A2